

150# Malleable Fittings • Spec Sheet

CHINESE



- Black & Galvanized
- Material: ASTM A197/A197M
- Dimensions:
 - ASME B16.3 covering 90° Elbows, 45° Elbows, Couplings, Reducers, 90° Street Elbows, 45° Street Elbows, Caps, Tees
 - ASME B16.39 covering Unions
 - ASME B16.14 covering Bushings, Plugs
- Threads: ASME B1.201
- Available: 1/8" through 6"
- Approvals: UL & FM approved

150# Malleable Fittings • Spec Sheet

CHINESE

90 Elbow

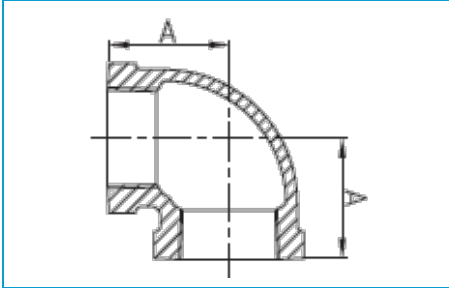

Size	1/8	1/4	3/8	1/2	3/4	1
A	0.69	0.81	0.95	1.12	1.31	1.50
Size	1-1/4	1-1/2	2	2-1/2	3	4
A	1.75	1.94	2.25	2.70	3.08	3.79
Size	5	6				
A	4.50	5.13				

45 Elbow

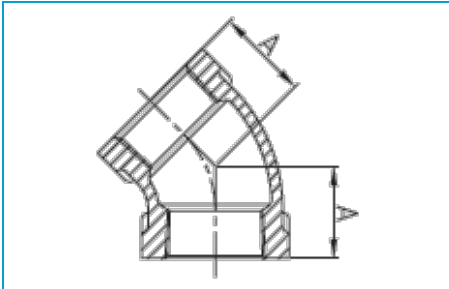

Size	1/8	1/4	3/8	1/2	3/4	1
A	0.63	0.73	0.80	0.88	0.98	1.12
Size	1-1/4	1-1/2	2	2-1/2	3	4
A	1.29	1.43	1.68	1.95	2.17	2.61
Size	5	6				
A	3.05	3.46				

90 Street Elbow

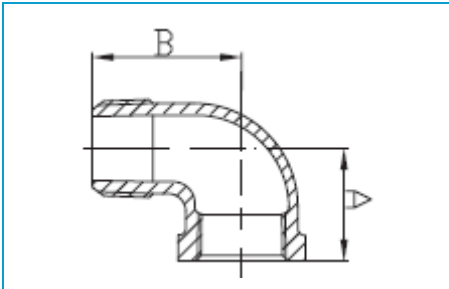

Size	1/8	1/4	3/8	1/2	3/4	1
A	0.69	0.81	0.95	1.12	1.31	1.50
B	1.00	1.19	1.44	1.62	1.89	2.14
Size	1-1/4	1-1/2	2	2-1/2	3	4
A	1.75	1.94	2.25	2.70	3.08	3.79
B	2.45	2.69	3.26	3.86	4.52	5.69

45 Street Elbow

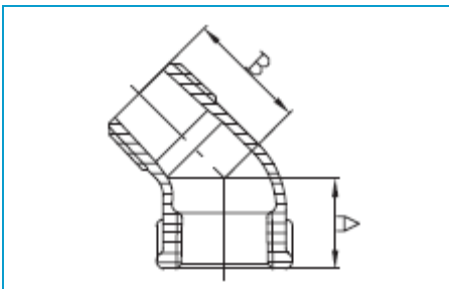

Size	1/8	1/4	3/8	1/2	3/4	1
A	0.63	0.73	0.80	0.88	0.98	1.12
B	0.83	0.94	1.03	1.15	1.29	1.47
Size	1-1/4	1-1/2	2	2-1/2	3	4
A	1.29	1.43	1.68	1.95	2.17	2.61
B	1.71	1.88	2.22	2.57	3.00	3.70

150# Malleable Fittings • Spec Sheet

CHINESE

Reducing Elbow

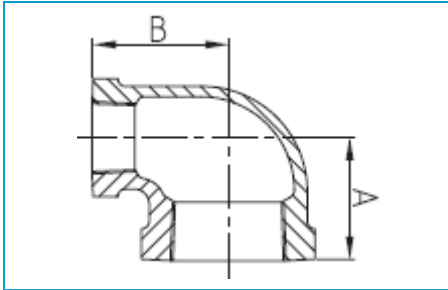

Size	1/4x1/8	3/8x1/8	3/8x1/4	1/2x1/4	1/2x3/8	3/4x1/4	3/4x3/8	3/4x1/2
A	0.74	0.81	0.88	0.97	1.04	1.05	1.12	1.20
B	0.76	0.85	0.90	0.98	1.03	1.08	1.13	1.22
Size	1x1/2	1x3/4	1-1/4x1/2	1-1/4x3/4	1-1/4x1	1-1/2x1/2	1-1/2x3/4	1-1/2x1
A	1.26	1.37	1.34	1.45	1.58	1.38	1.52	1.65
B	1.40	1.45	1.53	1.62	1.67	1.64	1.75	1.80
Size	1-1/2x1-1/4	2x1/2	2x3/4	2x1	2x1-1/4	2x1-1/2	2-1/2x1-1/4	
A	1.82	1.48	1.60	1.73	1.90	2.02	1.99	
B	1.88	1.87	1.97	2.02	2.10	2.16	2.36	
Size	2-1/2x1-1/2	2-1/2x2	3x1-1/2	3x2	3x2-1/2	4x2	4x3	
A	2.16	2.39	2.29	2.52	2.83	2.72	3.30	
B	2.51	2.60	2.84	2.89	2.99	3.43	3.60	

Side Outlet Elbow

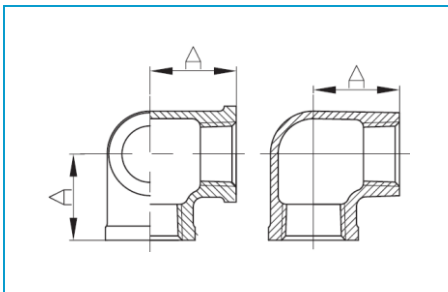

Size	1/2	3/4
A	1.10	1.30

Tee

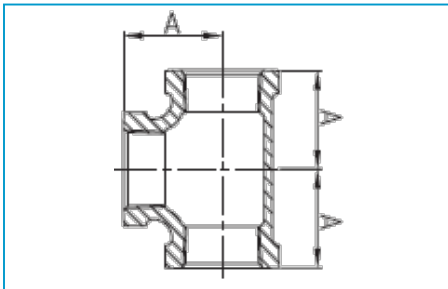

Size	1/8	1/4	3/8	1/2	3/4	1
A	0.69	0.81	0.95	1.12	1.31	1.50
Size	1-1/4	1-1/2	2	2-1/2	3	4
A	1.75	1.94	2.25	2.70	3.08	3.79
Size	5	6				
A	4.50	5.13				

Street Service Tee

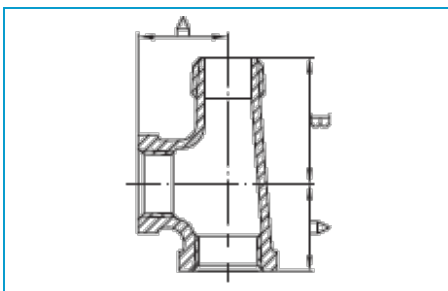

Size	1/2	3/4	1
A	1.12	1.31	1.50
B	1.62	1.89	2.14

150# Malleable Fittings • Spec Sheet

CHINESE

Reducing Tee

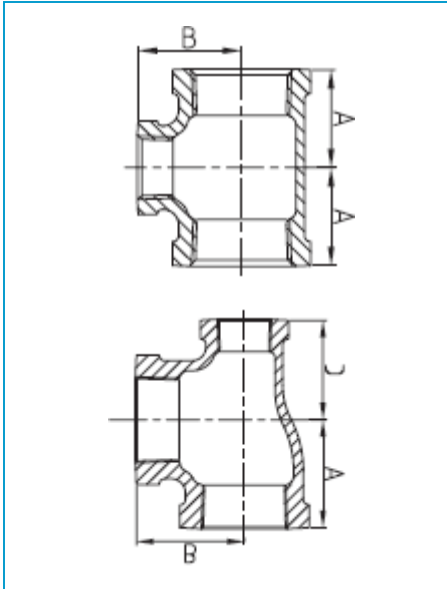

Size	1/2x1/4	1/2x3/8	3/4x1/4	3/4x3/8	3/4x1/2	1x1/4	1x3/8	1x1/2	1x3/4
A	0.97	1.04	1.05	1.12	1.20	1.11	1.18	1.26	1.37
B	0.98	1.03	1.08	1.13	1.22	1.22	1.28	1.40	1.45
Size	1-1/4x1/2	1-1/4x3/4	1-1/4x1	1-1/2x1/2	1-1/2x3/4	1-1/2x1-1/4	2x1/2	2x3/4	
A	1.34	1.45	1.58	1.41	1.52	1.82	1.49	1.60	
B	1.53	1.62	1.67	1.66	1.75	1.88	1.88	1.97	
Size	2x1	2x1-1/4	2x1-1/2	2-1/2x1/2	2-1/2x3/4	2-1/2x1	2-1/2x1-1/2		
A	1.73	1.90	2.02	1.62	1.74	1.87	2.16		
B	2.02	2.10	2.16	2.25	2.32	2.37	2.51		
Size	2-1/2x2	3x1	3x1-1/4	3x1-1/2	3x2	3x2-1/2	4x2	4x2-1/2	4x3
A	2.39	2.00	2.17	2.29	2.52	2.83	2.74	3.05	3.30
B	2.60	2.66	2.74	2.80	2.89	2.99	3.41	3.51	3.60
Size	1/2x1/4x1/2	3/4x1/2x1/2	3/4x1/2x3/4	3/4x1/2x1	1x1/4x1	1x1/2x1/2	1x1/2x3/4	1x1/2x1	
A	1.12	1.20	1.31	1.50	1.46	1.26	1.37	1.50	
B	1.12	1.22	1.31	1.34	1.46	1.40	1.45	1.50	
C	0.98	1.12	1.22	1.30	1.18	1.12	1.22	1.40	

Size	1x3/4x3/4	1x3/4x1	1-1/4x1/2x1/2	1-1/4x1/2x3/4	1-1/4x1/2x1-1/4	1-1/4x3/4x1/2	1-1/4x3/4x3/4	1-1/4x3/4x1	1-1/4x3/4x1-1/4	1-1/4x1x1/2	
A	1.37	1.50	1.34	1.38	1.75	1.58	1.45	1.58	1.75	1.34	
B	1.45	1.50	1.50	1.50	1.75	1.67	1.62	1.67	1.75	1.53	
C	1.31	1.45	1.06	1.14	1.53	1.46	1.31	1.45	1.62	1.26	
Size	1-1/4x1x3/4	1-1/4x1x1	1-1/4x1x1-1/4	1-1/2x1/2x1	1-1/2x1/2x1-1/2	1-1/2x3/4x3/4	1-1/2x3/4x1	1-1/2x3/4x1-1/4	1-1/2x3/4x1-1/2	1-1/2x1x1	
A	1.45	1.58	1.75	1.73	1.94	1.50	1.73	1.81	1.94	1.65	
B	1.62	1.67	1.75	1.81	1.94	1.69	1.81	1.89	1.94	1.80	
C	1.37	1.50	1.67	1.34	1.66	1.26	1.38	1.62	1.75	1.50	
Size	1-1/2x1x1-1/2	1-1/2x1-1/4x1/2	1-1/2x1-1/4x3/4	1-1/2x1-1/4x1	1-1/2x1-1/4x1-1/4	1-1/2x1-1/4x1-1/2	2x1/2x2	2x3/4x2	2x1x1		
A	1.94	1.41	1.52	1.65	1.82	1.94	2.25	2.25	1.73		
B	1.94	1.66	1.75	1.80	1.88	1.94	2.25	2.25	2.01		
C	1.80	1.34	1.43	1.58	1.75	1.88	1.88	1.97	1.50		
Size	2x1x1-1/2	2x1x2	2x1-1/4x1	2x1-1/4x1-1/4	2x1-1/4x1-1/2	2x1-1/4x2	2x1-1/2x3/4	2x1-1/2x1	2x1-1/2x1-1/4	2x1-1/2x1-1/2	2x1-1/2x2
A	2.02	2.25	1.58	1.90	2.02	2.25	1.56	1.73	1.90	2.02	2.25
B	2.16	2.25	2.01	2.10	2.16	2.25	1.93	2.02	2.10	2.16	2.25
C	1.80	2.02	1.73	1.75	1.88	2.10	1.48	1.65	1.82	1.94	2.16

Side Outlet Tee

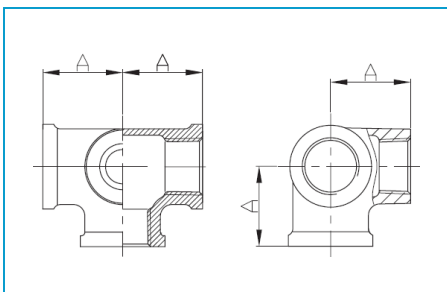

Size	1/2	3/4
A	1.10	1.30

150# Malleable Fittings • Spec Sheet

CHINESE

Bull Head Tee

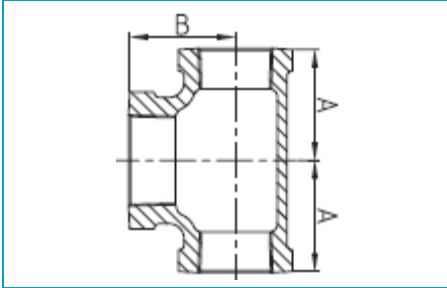

Size	1/2x1/2x3/4	1/2x1/2x1	3/4x3/4x1	1x1x1-1/4	1x1x1-1/2
A	1.22	1.36	1.45	1.67	1.80
B	1.20	1.26	1.37	1.58	1.65

Size	1x1x2	1-1/4x1-1/4x1-1/2	1-1/2x1-1/2x2	2x2x2-1/2
A	2.02	1.88	2.16	2.60
B	1.93	1.82	2.02	2.39

Square Head Plug

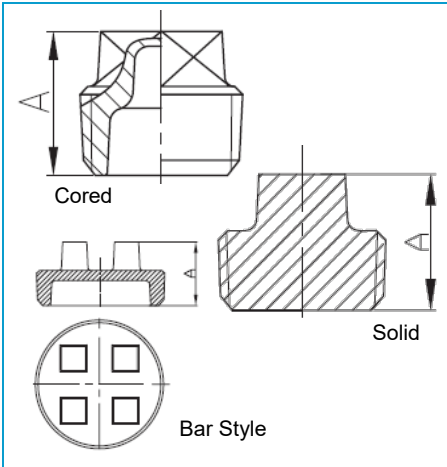

Size	1/8	1/4	3/8	1/2	1/2 (Solid)	3/4
A	0.61	0.72	0.79	0.94	0.94	1.07

Size	1	1-1/4	1-1/2	2	2-1/2	3
A	1.23	1.36	1.45	1.56	1.81	1.93

Size	4	4 (Bar Style)	6	6 (Bar Style)
A	2.54	2.22	2.82	2.66

Square Countersunk Plug

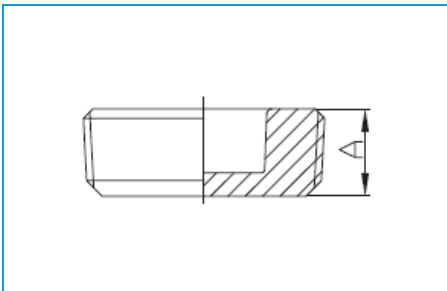

Size	1	1-1/2	2
A	0.75	0.83	0.88

Cross

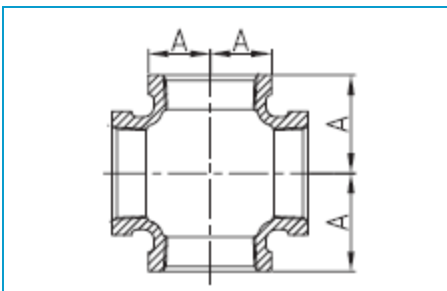

Size	1/4	3/8	1/2	3/4	1
A	0.81	0.95	1.12	1.31	1.50

Size	1-1/4	1-1/2	2	2-1/2
A	1.75	1.94	2.25	2.70

150# Malleable Fittings • Spec Sheet

CHINESE

Extension Piece

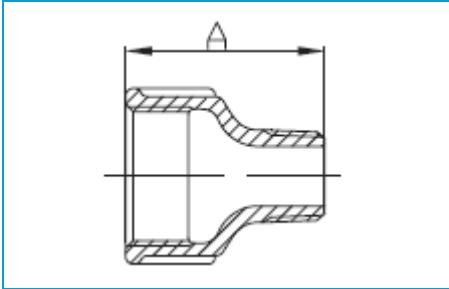

Size	1/2	3/4
A	1.69	1.89

Floor Flange

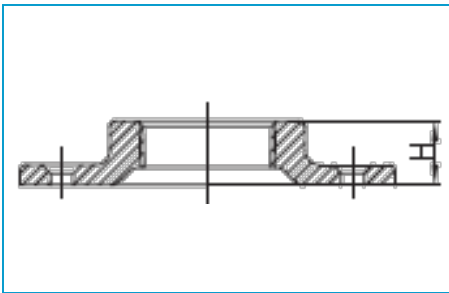

Size	1/4	3/8	1/2	3/4	1
H	0.47	0.55	0.55	0.63	0.67
Size	1-1/4	1-1/2	2		
H	0.75	0.87	0.99		

Union

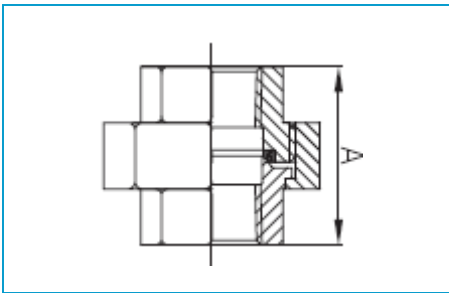

Size	1/8	1/4	3/8	1/2	3/4	1
A	1.26	1.44	1.62	1.71	1.95	2.07
Size	1-1/4	1-1/2	2	2-1/2	3	4
A	2.27	2.40	2.76	3.23	3.51	3.86

Cap

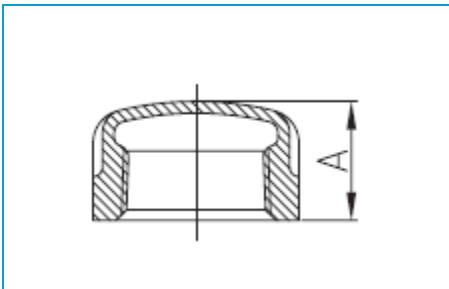

Size	1/8	1/4	3/8	1/2	3/4	1	1-1/4
A	0.53	0.63	0.74	0.87	0.97	1.16	1.28
Size	1-1/2	2	2-1/2	3	4	5	6
A	1.33	1.45	1.70	1.80	2.08	2.32	2.55

150# Malleable Fittings • Spec Sheet

CHINESE

Coupling

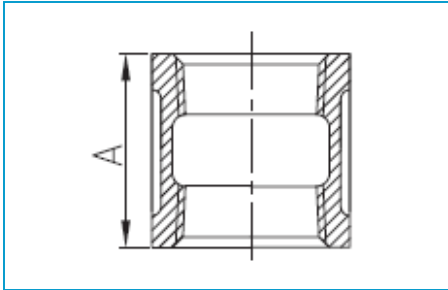

Size	1/8	1/4	3/8	1/2	3/4	1	1-1/4
A	0.95	1.06	1.16	1.34	1.54	1.67	1.93
Size	1-1/2	2	2-1/2	3	4	5	6
A	2.15	2.53	2.88	3.18	3.69	3.74	4.14

Reducing Coupling

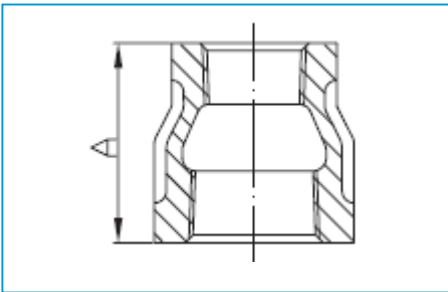

Size	1/4x1/8	3/8x1/8	3/8x1/4	1/2x1/8	1/2x1/4	1/2x3/8	3/4x1/8
A	1.00	1.13	1.13	1.25	1.25	1.25	1.44
Size	3/4x1/4	3/4x3/8	3/4x1/2	1x1/4	1x3/8	1x1/2	1x3/4
A	1.44	1.44	1.44	1.69	1.69	1.69	1.69
Size	1-1/4x3/8	1-1/4x1/2	1-1/4x3/4	1-1/4x1	1-1/2x3/8	1-1/2x1/2	1-1/2x3/4
A	2.06	2.06	2.06	2.06	2.31	2.31	2.31
Size	1-1/2x1	1-1/2x1-1/4	2x3/8	2x1/2	2x3/4	2x1	2x1-1/4
A	2.31	2.31	2.81	2.81	2.81	2.81	2.81
Size	2x1-1/2	2-1/2x1/2	2-1/2x3/4	2-1/2x1	2-1/2x1-1/4	2-1/2x1-1/2	
A	2.81	3.25	3.25	3.25	3.25	3.25	
Size	2-1/2x2	3x1/2	3x3/4	3x1	3x1-1/4	3x1-1/2	3x2
A	3.25	3.69	3.69	3.69	3.69	3.69	3.69
Size	3x2-1/2	4x1-1/2	4x2	4x2-1/2	4x3		
A	3.69	4.39	4.39	4.39	4.39		

Right & Left Coupling

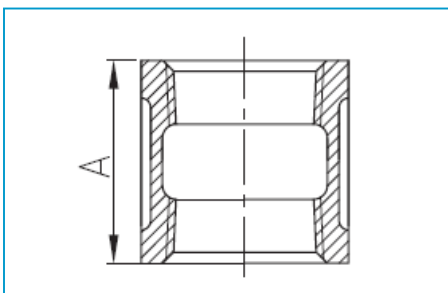

Size	1/2	3/4	1	1-1/4	1-1/2	2
A	1.34	1.52	1.67	1.93	2.15	2.53
Size	2-1/2	3	4			
A	2.88	3.18	3.69			

150# Malleable Fittings • Spec Sheet

CHINESE

Outside Hex Bushing

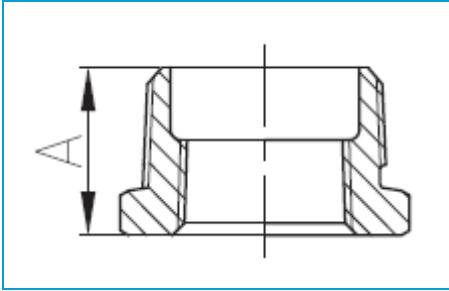

Size	1/4x1/8	3/8x1/8	3/8x1/4	1/2x1/8	1/2x1/4	1/2x3/8	3/4x1/8
A	0.58	0.64	0.64	0.75	0.75	0.75	0.85
Size	3/4x1/4	3/4x3/8	3/4x1/2	1x1/2	1x3/4	1-1/4x3/4	1-1/4x1
A	0.85	0.85	0.85	1.00	1.00	1.08	1.08
Size	1-1/2x1	1-1/2x1-1/4	2x1-1/4	2x1-1/2	2-1/2x1-1/2	2-1/2x2	
A	1.14	1.14	1.22	1.22	1.51	1.44	
Size	3x2	3x2-1/2	4x3	5x4	6x5		
A	1.61	1.53	1.72	1.81	2.03		

Inside Hex Bushing

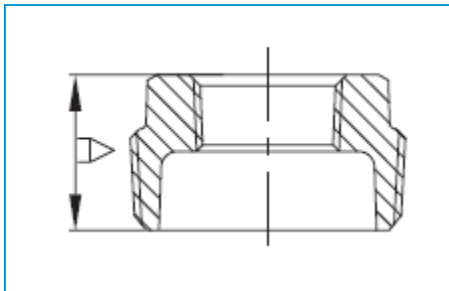

Size	1x1/8	1x1/4	1x3/8	1-1/4x3/8	1-1/4x1/2	1-1/2x1/4	1-1/2x3/8	
A	1.05	1.05	1.05	1.14	1.14	1.20	1.20	
Size	1-1/2x1/2	1-1/2x3/4	2x1/4	2x3/8	2x1/2	2x3/4	2x1	
A	1.20	1.20	1.29	1.29	1.29	1.29	1.29	
Size	2-1/2x1/2	2-1/2x3/4	2-1/2x1/2	2-1/2x3/4	3x1	3x1-1/4	3x1-1/2	
A	1.51	1.51	1.51	1.51	1.61	1.61	1.61	
Size	4x1	4x1-1/4	4x1-1/2	4x2	4x2-1/2	6x2	6x3	6x4
A	1.82	1.82	1.82	1.82	1.82	2.16	2.16	2.16

Locknut

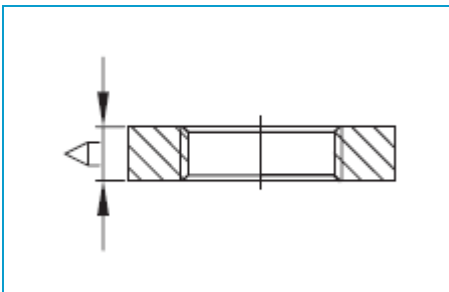

Size	1/2	3/4	1	1-1/4	1-1/2	2
A	0.31	0.34	0.38	0.42	0.47	0.53



CALIFORNIA 5593 Fresca Dr., La Palma CA 90623
TEXAS 1150 Silber Rd., Houston TX 77055
ILLINOIS 278 Windy Point Dr., Glendale Heights, IL 60139
NEW YORK PO Box 27, Rt.22, Brewster NY 10509
 WEB: www.matco-norca.com

• Phone: 866-532-8306 • Fax: 866-532-8307
 • Phone: 800-935-5456 • Fax: 713-680-2999
 • Phone: 844-412-5068 • Fax: 800-640-2252
 • Phone: 800-431-2082 • Fax: 845-278-9056
 EMAIL: mail@matco-norca.com